

EPDM profily

EPDM sponge profily

Mikroporézne profily

Termoplasty

NBR profily

Ostatné profily a tovar

PVC profily



VERZIA: 2.08/11

MAJK s.r.o.
976 68 Heľpa 1108
Slovenská republika

Tel./Fax: +421/ 48/ 618 62 78

Tel./Fax: +421/ 48/ 618 65 11

Tel.: +421/ 48/ 618 60 01

majk@majk.sk
<http://www.majk.sk>



VÝZNAM A POUŽITIE

Profily z EPDM gummy /BAU 70/ (ďalej len EPDM profily) je druh tesnenia z kompaktnéj gummy na báze Etylén - Propylén - Dien kaučuku s anorganickými aorganickými prísadami (ako napr. rôzne plnivá, vzdúvadlá, zahusťovacie činidlá, prísady proti starnutiu a zmäkčovadlá) rôznych tvarov a veľkosti. Neprepúšťajú vzduch a nemajú prakticky žiadnu nasiakavosť. Odolávajú poveternostným vplyvom v rozmedzí teplôt -40 °c až +100 °c bez zmeny fyzikálnych, mechanických a chemických vlastností. Krátkodobo tesnenia odolávajú teplotám do +130 °C, avšak je potrebné počítať s predčasným starnutím a zmenou ich vlastností. Sú vyrábané v tvrdosti 70 +/- 5 °ShA.

Povrch tesnenia je hladký a čierny (príp. podľa dohovoru aj farebný). EPDM profily sa vyrábajú v niekoľkých základných tvaroch, buď ako štvorec, obdĺžnik, kruhové tesnenie, medzikružia a rôzne špeciálne tesnenia, v závislosti od požiadaviek zákazníka. Pokiaľ však odberateľ požadujete iný tvar alebo iný rozmer, ako je uvedený v katalógu a predloží požiadavkový list (resp. jeho bližšiu špecifikáciou) na vývoj tohto tesnenia doplnený náčrtom, je možné po dohode s vedúcim výroby a majiteľom spoločnosti, tento vyrobiť.

Použitie - EDPM profily sú svojim mechanickými, fyzikálnymi, chemickými vlastnosťami a trvalou deformáciou predurčené ako tesnenia konštrukčných a stavebných častí v rôznych odvetviach priemyslu, ako aj tesnenia pre automobilový priemysel.

SÚVISIACE NORMY

- STN 62 0002 Triedenie a označovanie gúm (september 1995)
 - STN 62 0011 Technické gumové výrobky (1. 1. 1993)
 - STN 62 2000 Materiálové listy gúm. Základné ustanovenie (november 1995)
 - STN 63 0001 Skladovanie gumových výrobkov (1. 1. 1993)
 - STN 63 0100 Medzné odchýlky rozmerov pre výrobky z technickej gummy (1. 1. 1993)
 - STN 63 0101 Tolerancie rozmerov výrobkov z gummy (1. 1. 1993)
 - STN 63 3001 Výrobky z gummy a plastov. Vytlačované profilové tesnenia. Všeobecné ustanovenia a skúšanie (1. 1. 1993)
- Podnikové normy THONY s.r.o., Uničov, Č. R.



TOLERANCIA

Povolené medzné odchýlky podľa príslušnej normy prierezu tesnenia z EPDM - kompaktnéj gumy sú uvedené v nasledujúcej tabuľke.

Rozmer v mm		Tolerancie
od	do	v mm (E3)
0	1,5	0,4
1,5	2,5	0,5
2,5	4,0	0,7
4,0	6,3	0,8
6,3	10,0	1,0
10,0	16,0	1,3
16,0	25,0	1,6
25,0	40,0	2,0
40,0	63,0	2,5
63,0	100,0	3,2

V prípade špecifických požiadaviek na toleranciu vzhľadom na použitie výrobku je potrebné dohodnúť s výrobcom iné hodnoty tolerancie, príp. uviesť tieto údaje pri objednávke. Polohu tolerancie, čiže jej umiestnenie, resp. rozloženie je možné podľa potreby meniť a to buď plusovo, mínusovo, prípadne obojstranne napr.:

Medzná odchýlka pri rozmere 5 mm s toleranciou 0,8 mm je možné rozložiť na

+0,80 alebo +0,00 alebo + 0,40 alebo + 0,20 a pod.
-0,00 -0,80 -0,40 -0,60

FORMA OBJEDNÁVKY

Každá faxová, poštou doručená alebo elektronickou poštou odoslaná objednávka musí okrem presnej adresy objednávateľa obsahovať všetky potrebné firemné iniciály, ako IČO, DIČ, peňažný ústav, číslo účtu, spôsob platby, telefonické spojenie, e-mail (ak je k dispozícii) termín splnenia, spôsob zaslania tovaru (zásielková spoločnosť, autom dodávateľa, vlastná doprava). Ďalej popis tovaru, počet metrov, prípadne cenu za 1 m bez DPH 19 %.

ĎALŠIE PONÚKANÉ SLUŽBY

- výroba nových profilov podľa požiadaviek zákazníka a po dohode s majiteľom, resp. vedúcim výroby
- po dohode prevedenie profilu na samolepiace.

UPOZORNENIE !

Katalóg má informatívny charakter.

Obrázky profilov nie sú zakreslené v mierke 1:1.



Profily štvorcového prierezu

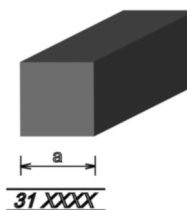

Číslo profilu	Rozmer AxA
310005/000000	5 x 5
310006/000000	6 x 6
310008/000000	8 x 8
310010/000000	10 x 10
310012/000000	12 x 12
310014/000000	14 x 14
310015/000000	15 x 15
310016/000000	16 x 16



Profily obdĺžnikového prierezu

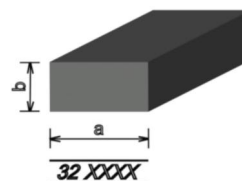

Číslo profilu	Rozmer AxB
320204/000000	4 x 2
320210/000000	10 x 2
320235/000000	35 x 2
320240/000000	40 x 2
320270/000000	70 x 2
320321/000000	21 x 3
320336/000000	36 x 3
320340/000000	40 x 3
320350/000000	50 x 3
320415.5/000000	15.5 x 4
320430/000000	30 x 4
320460/000000	60 x 4
320508/000000	8 x 5
320530/000000	30 x 5
320540/000000	40 x 5
320550/000000	50 x 5
320580/000000	80 x 5
320680/000000	80 x 6
320812/000000	12 x 8
320825/000000	25 x 8
320840/000000	40 x 8
321015/000000	15 x 10
321030/000000	30 x 10
321040/000000	40 x 10
321050/000000	50 x 10
321225/000000	25 x 12

Číslo profilu	Rozmer AxB
321520/000000	20 x 15
321530/000000	30 x 15
321835/000000	35 x 18
322029/000000	29 x 20
322025/000100	25 x 20
322080/000000	80 x 20



Profily kruhového prierezu

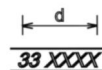
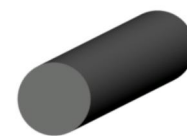

Číslo profilu	Rozmer d
330001.5/000000	1,5
330002/000000	2
330003/000000	3
330003.5/000000	3,5
330004/000000	4
330005/000000	5
330006/000000	6
330007/000000	7
330007.5/000000	7,5
330008/000000	8
330010/000000	10
330012/000000	12
330015/000000	15
330018/000000	18
330030/000000	30
330045/000000	45



Profily medzikružného prierezu

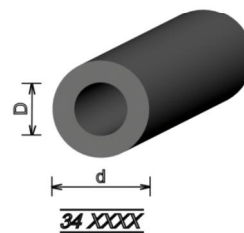

Číslo profilu	Rozmer d / D
340406/000000	6 / 4
340407/000000	7 / 4
340412/000000	12 / 4
340507/000000	7 / 5
340510/000000	10 / 5
340613/000000	13 / 6
341014/000000	14 / 10
342125/000100	25 / 21
342550/000000	50 / 25
343258/000000	58 / 32

PROFILY Z EPDM-KOMPAKTNEJ GUMY

Ukážky jednotlivých profilov

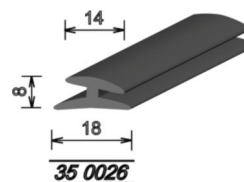
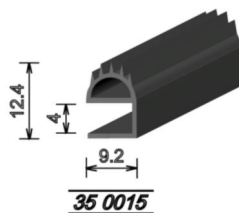
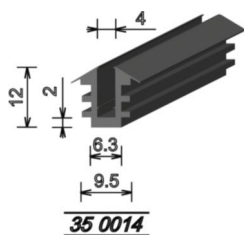
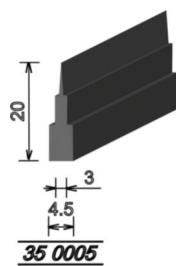
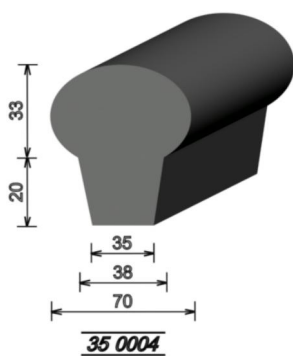
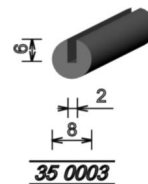
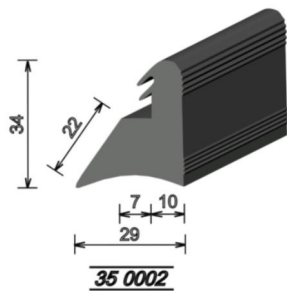
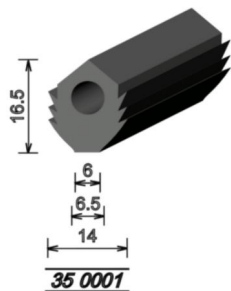

PROFILY Z EPDM-KOMPAKTNEJ GUMY

Ukážky jednotlivých profilov

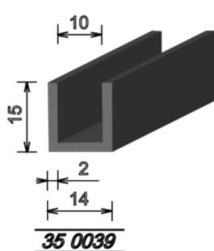
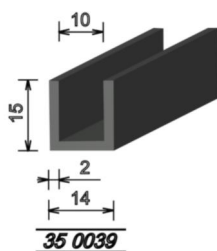
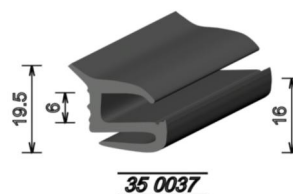
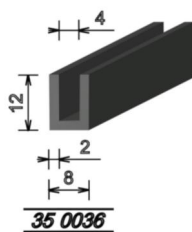
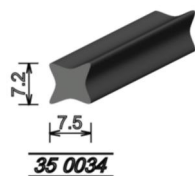
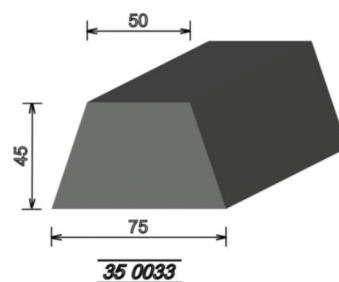
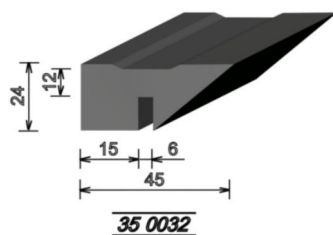
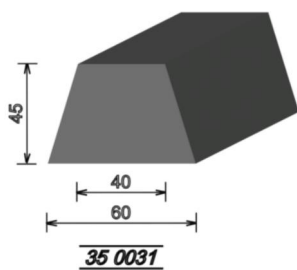

PROFILY Z EPDM-KOMPAKTNEJ GUMY

Ukážky jednotlivých profilov

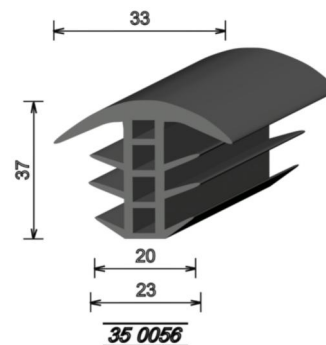
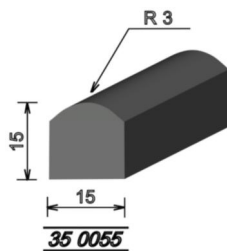
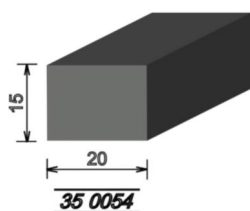
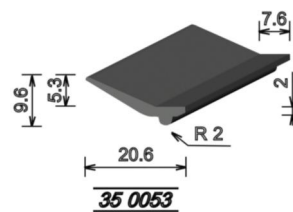
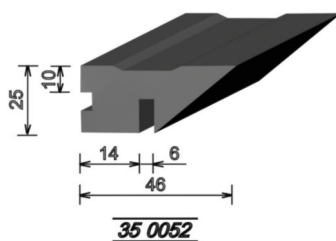
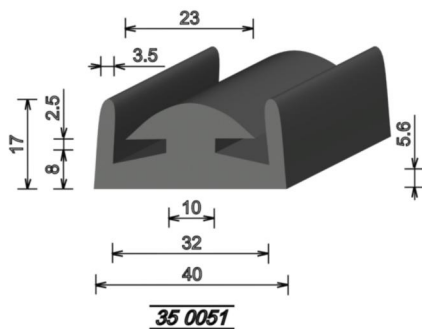
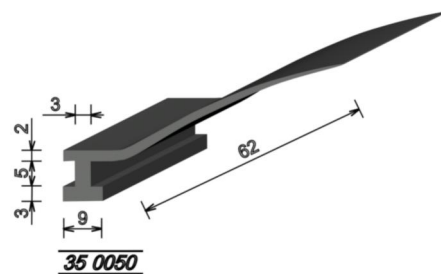
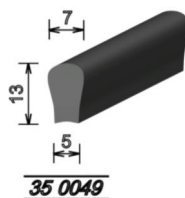
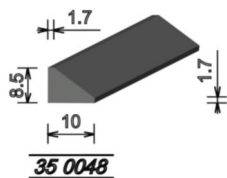
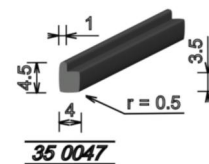
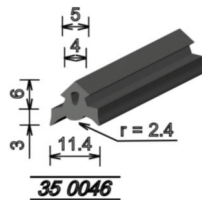
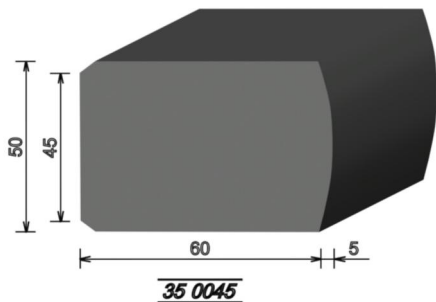

PROFILY Z EPDM-KOMPAKTNEJ GUMY

Ukážky jednotlivých profilov

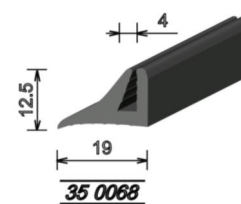
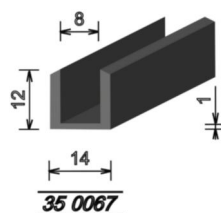
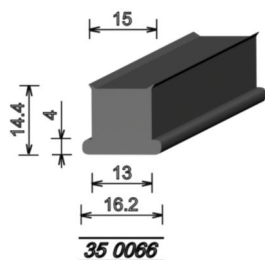
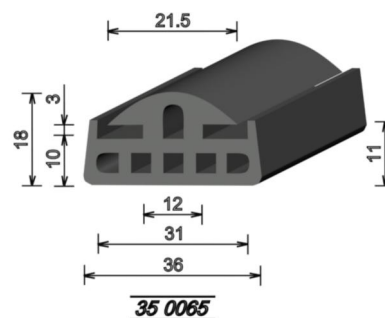
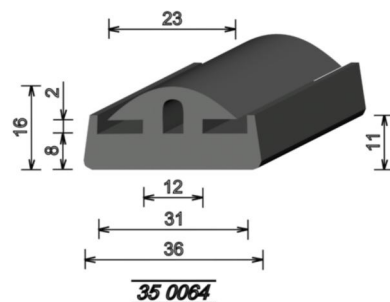
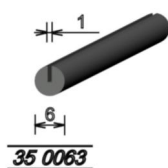
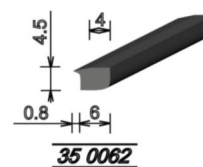
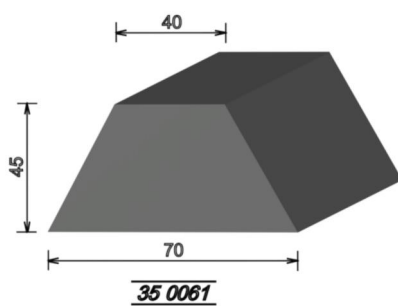
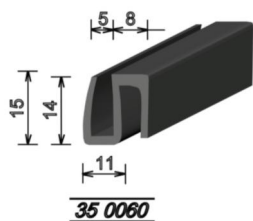
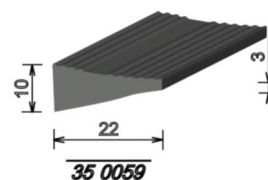
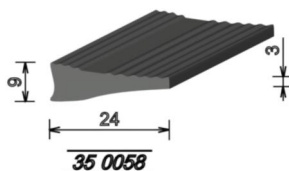
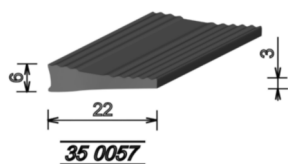

PROFILY Z EPDM-KOMPAKTNEJ GUMY

Ukážky jednotlivých profilov

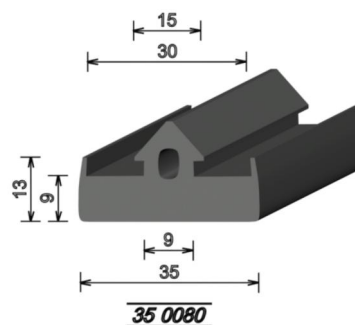
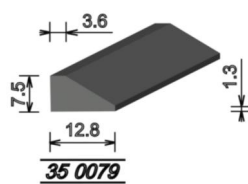
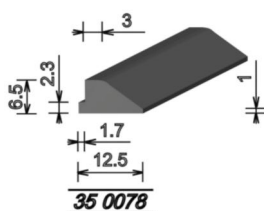
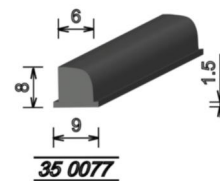
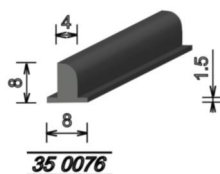
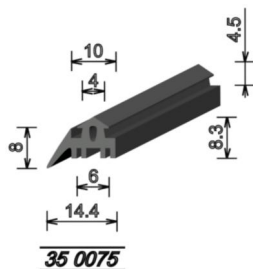
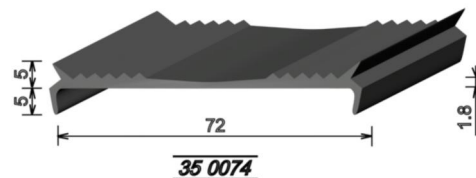
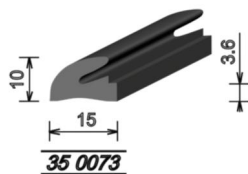
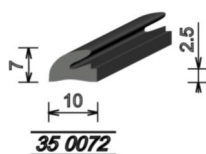
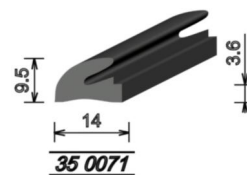
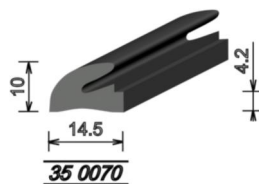
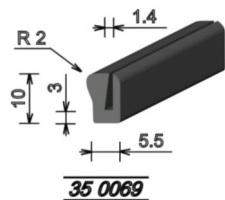

PROFILY Z EPDM-KOMPAKTNEJ GUMY

Ukážky jednotlivých profilov

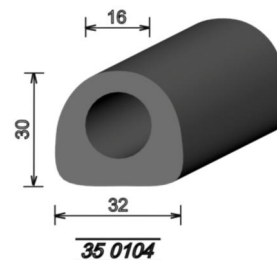
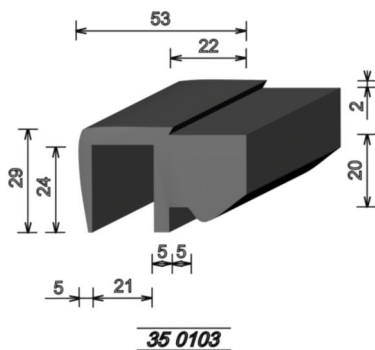
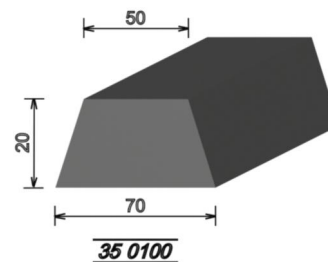
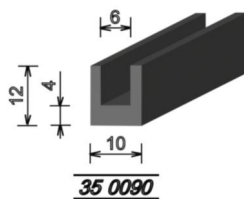
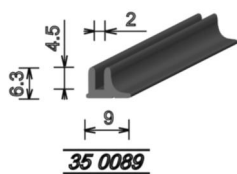
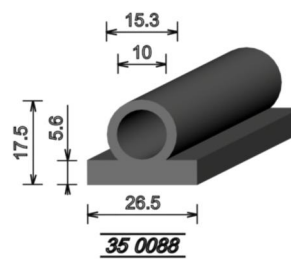
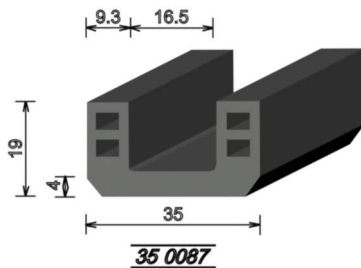
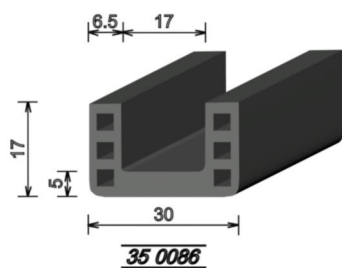
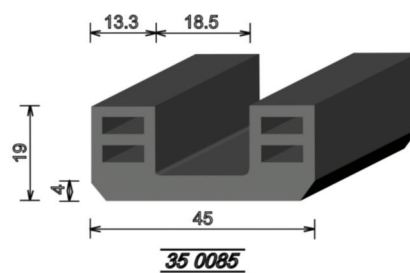
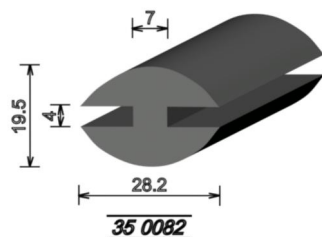
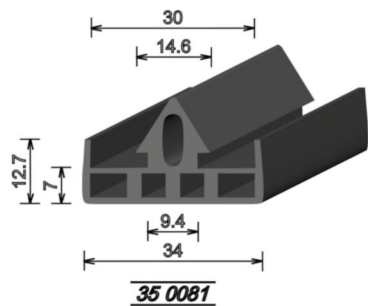

PROFILY Z EPDM-KOMPAKTNEJ GUMY

Ukážky jednotlivých profilov

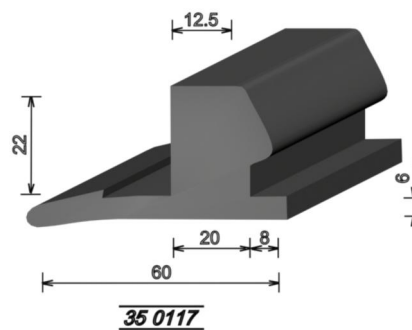
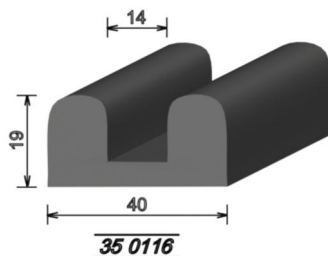
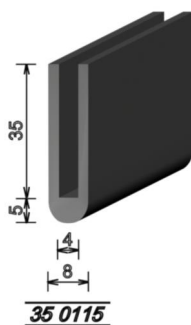
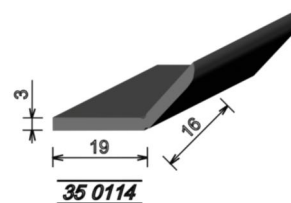
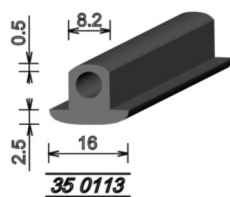
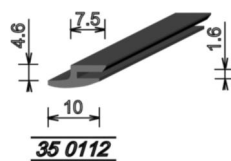
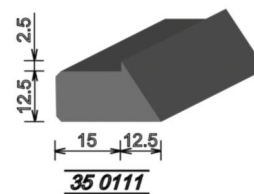
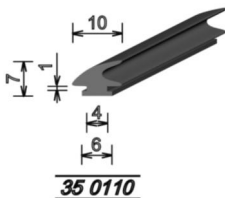
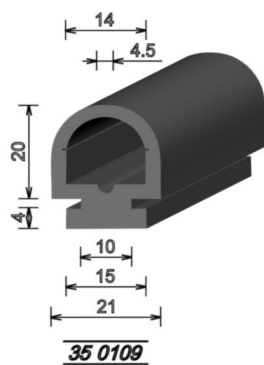
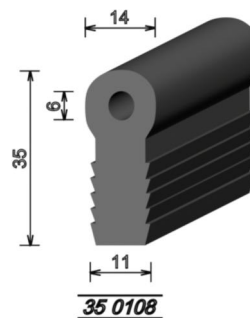
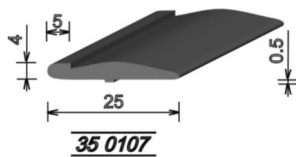
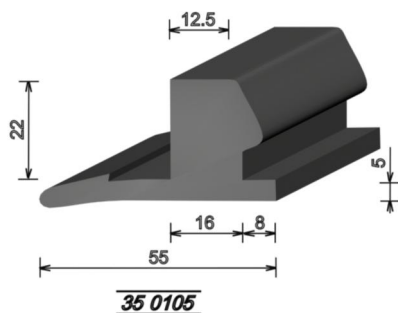

PROFILY Z EPDM-KOMPAKTNEJ GUMY

Ukážky jednotlivých profilov

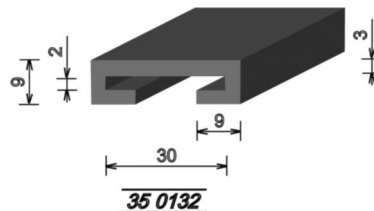
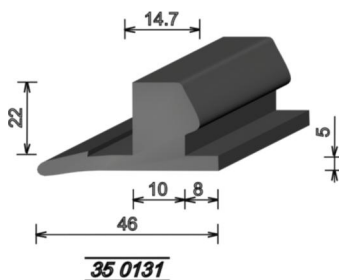
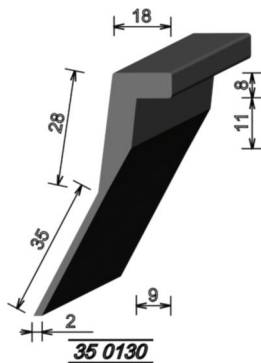
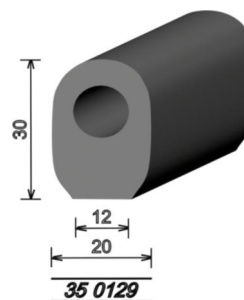
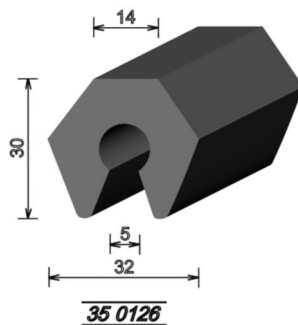
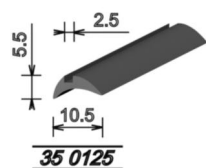
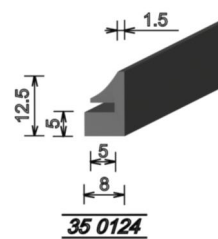
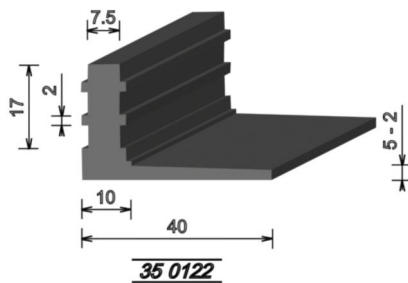
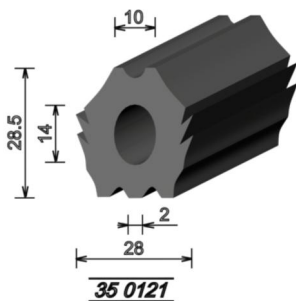
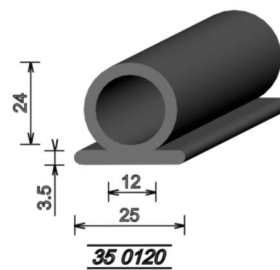
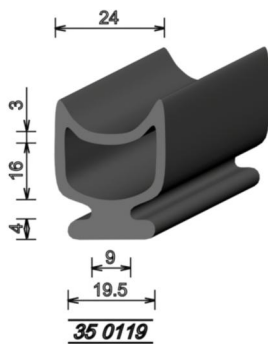
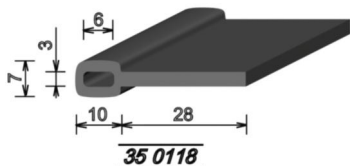

PROFILY Z EPDM-KOMPAKTNEJ GUMY

Ukážky jednotlivých profilov

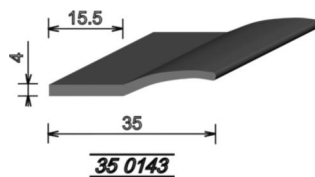
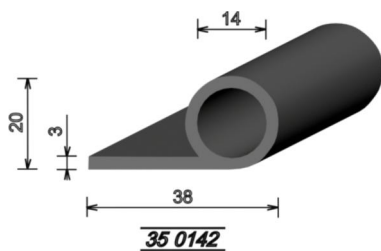
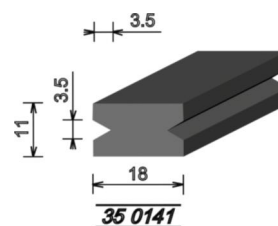
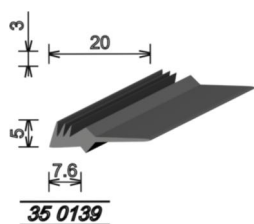
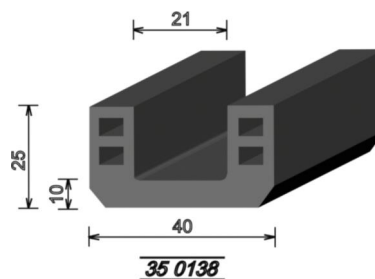
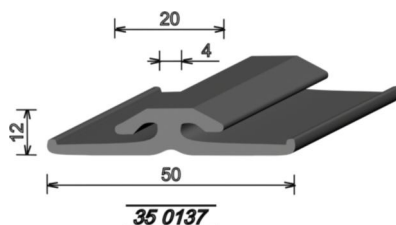
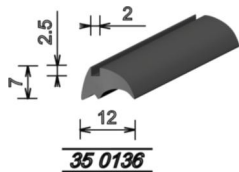
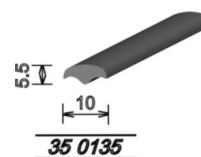
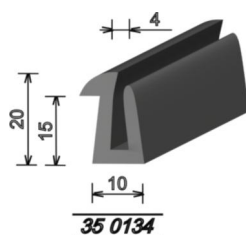
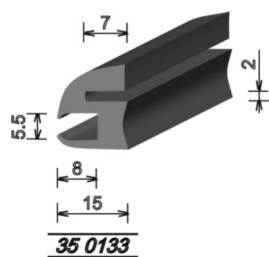

PROFILY Z EPDM-KOMPAKTNEJ GUMY

Ukážky jednotlivých profilov

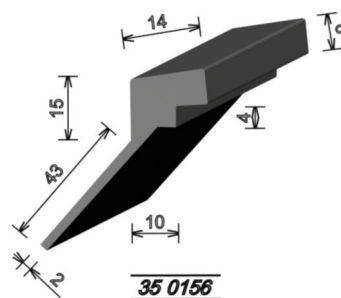
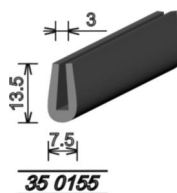
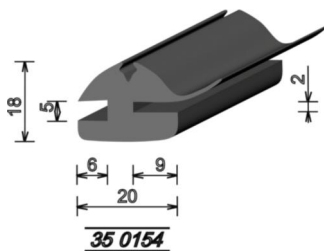
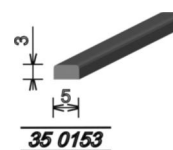
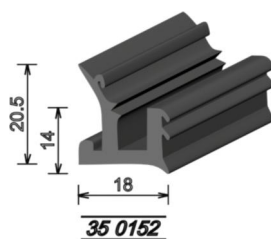
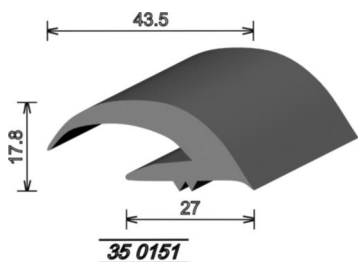
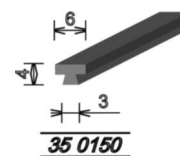
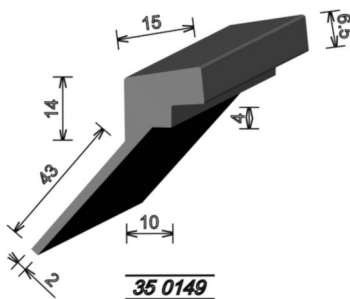
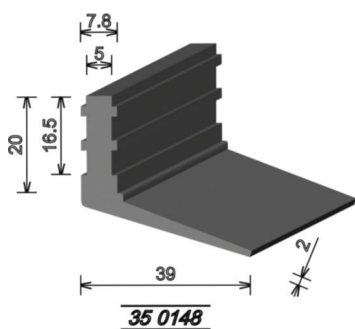
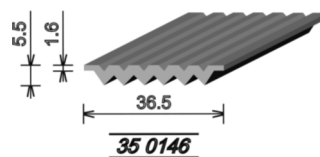
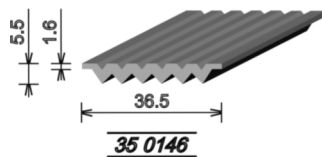
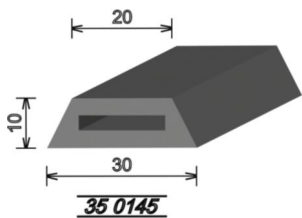

PROFILY Z EPDM-KOMPAKTNEJ GUMY

Ukážky jednotlivých profilov

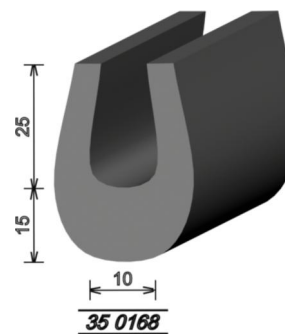
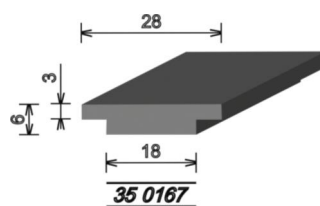
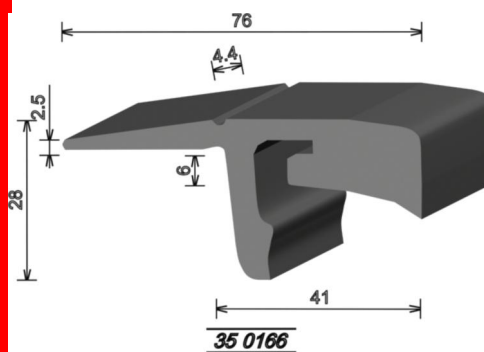
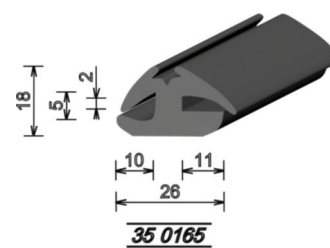
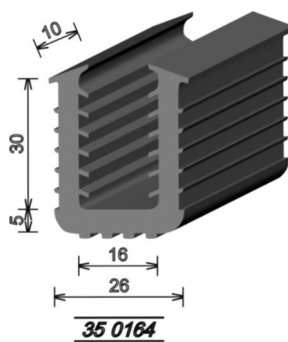
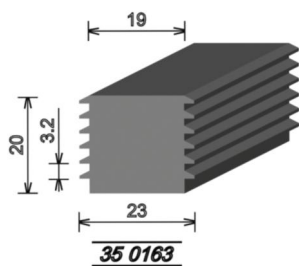
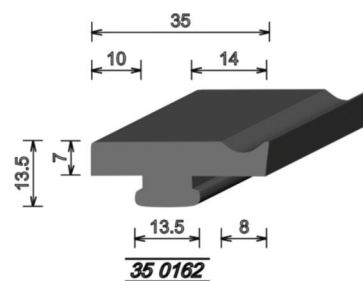
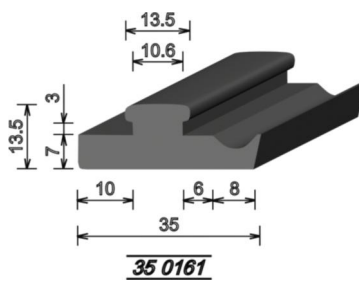
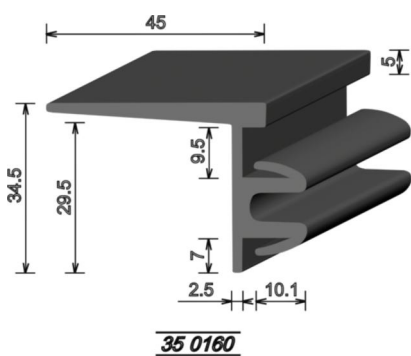
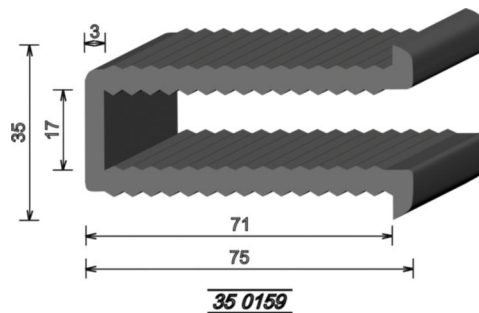
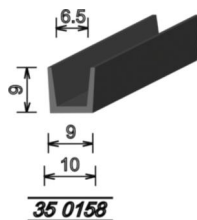
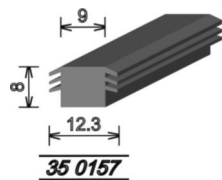

PROFILY Z EPDM-KOMPAKTNEJ GUMY

Ukážky jednotlivých profilov

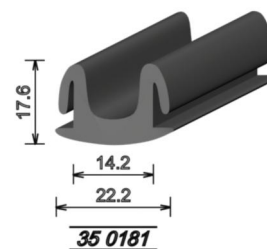
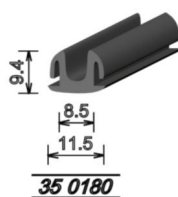
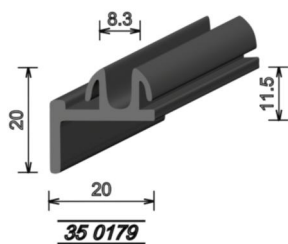
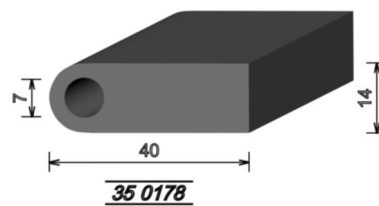
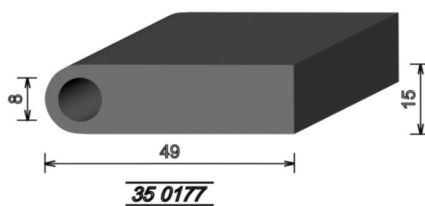
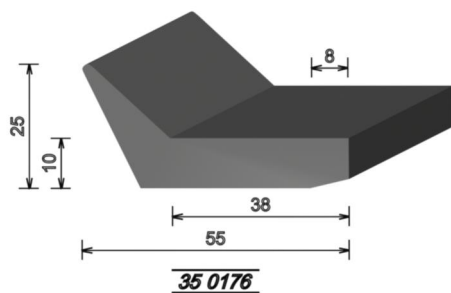
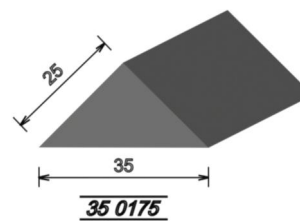
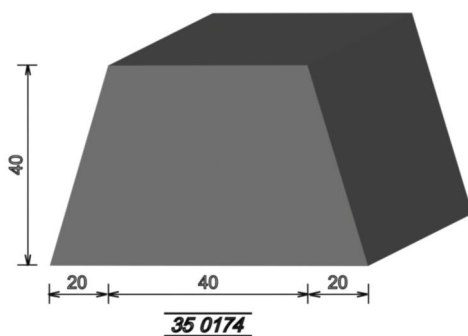
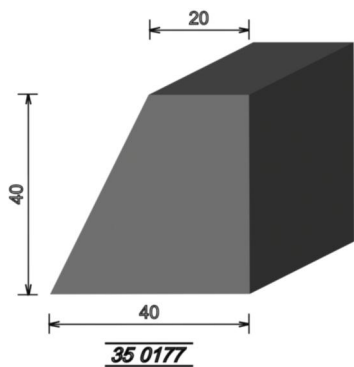
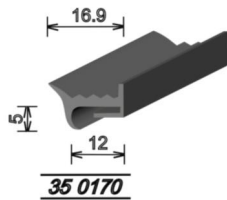
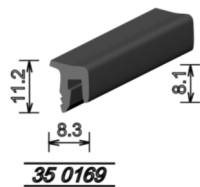

PROFILY Z EPDM-KOMPAKTNEJ GUMY

Ukážky jednotlivých profilov

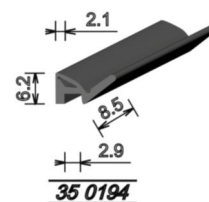
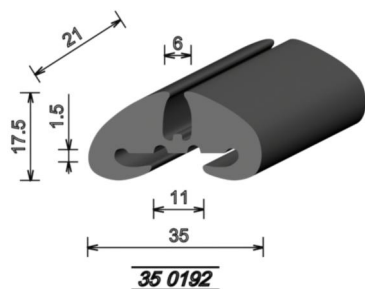
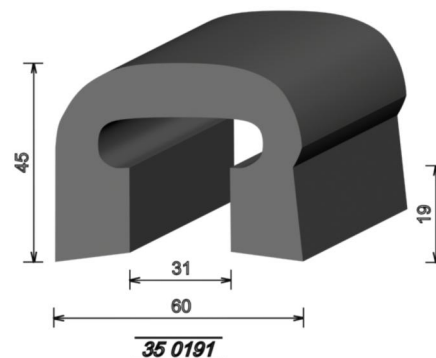
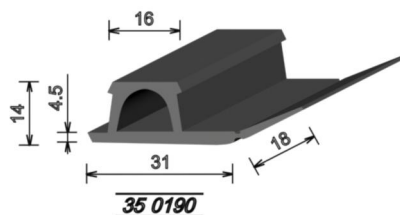
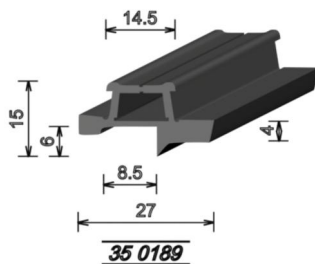
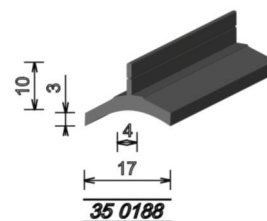
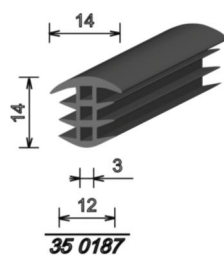
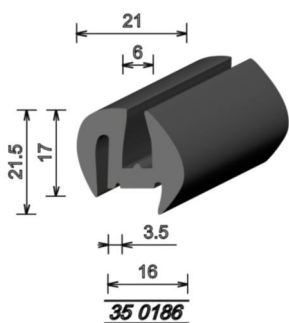
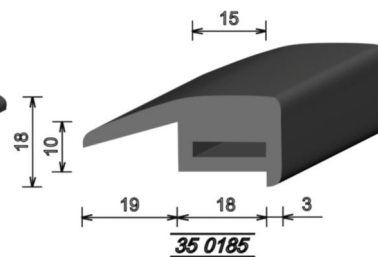
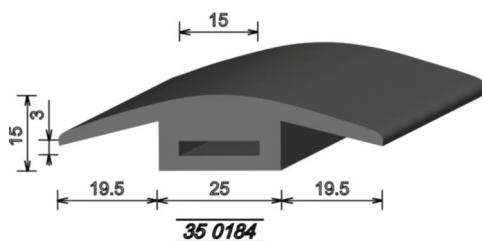
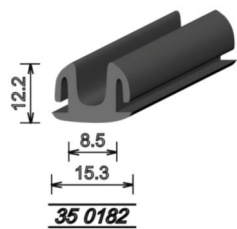

PROFILY Z EPDM-KOMPAKTNEJ GUMY

Ukážky jednotlivých profilov

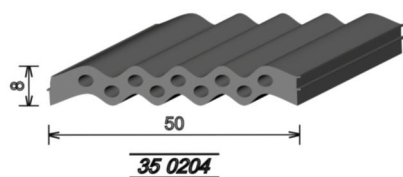
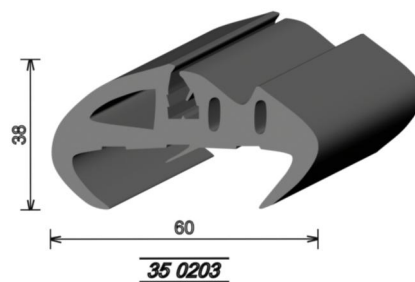
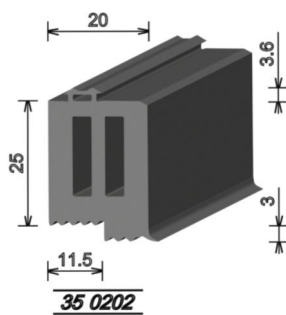
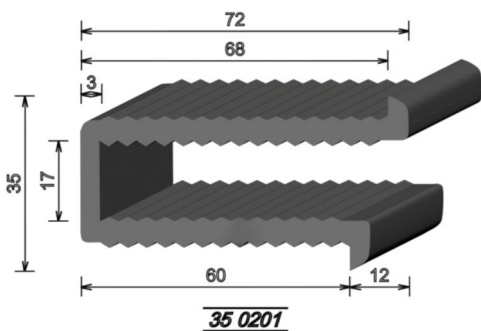
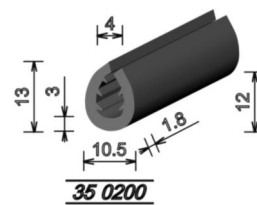
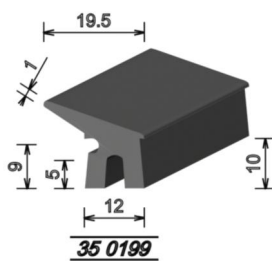
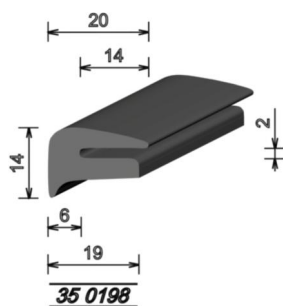
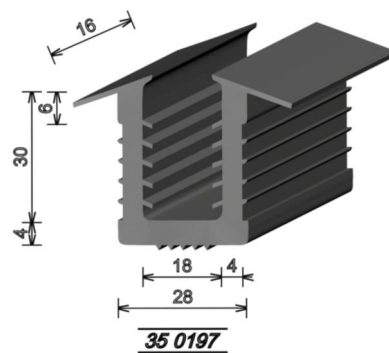
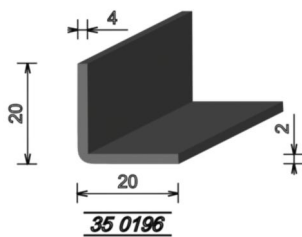
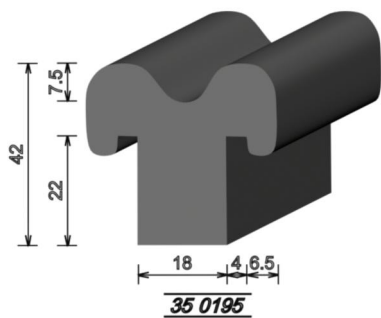

PROFILY Z EPDM-KOMPAKTNEJ GUMY

Ukážky jednotlivých profilov

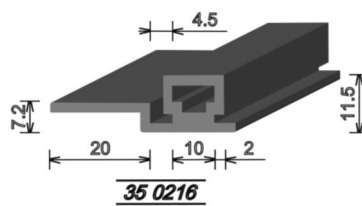
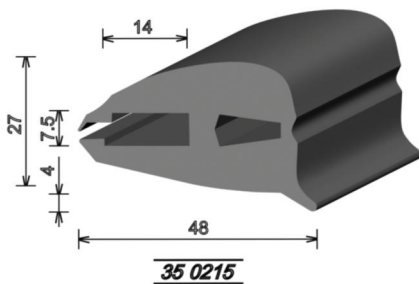
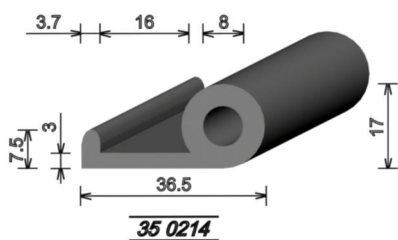
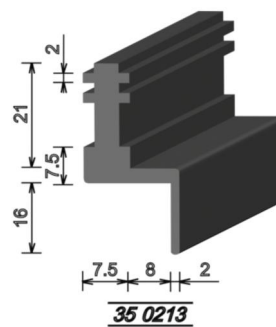
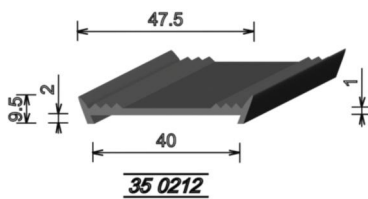
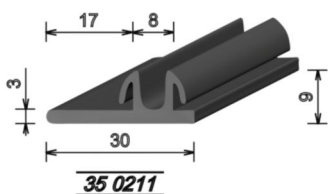
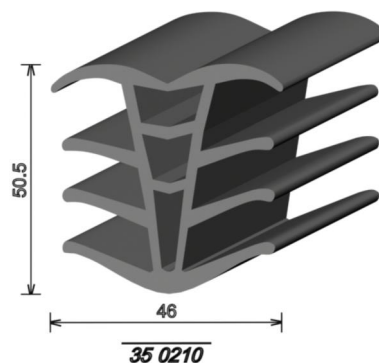
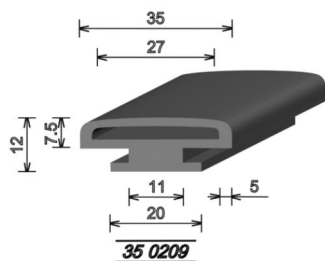
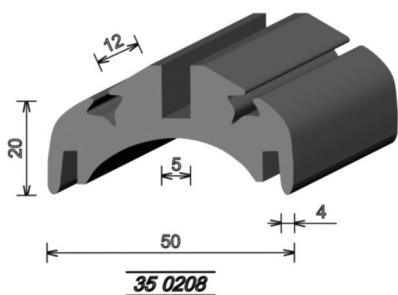
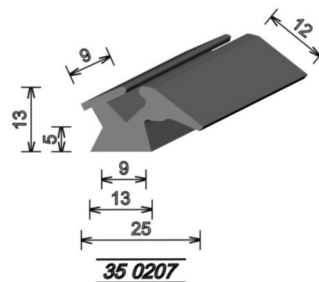
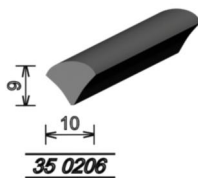
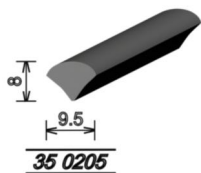

PROFILY Z EPDM-KOMPAKTNEJ GUMY

Ukážky jednotlivých profilov

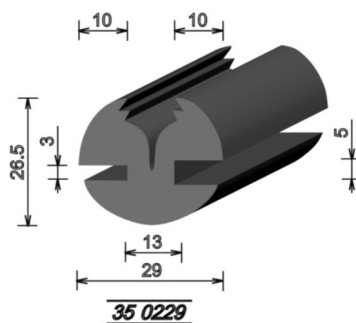
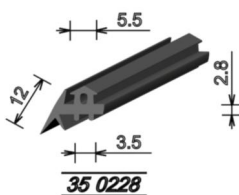
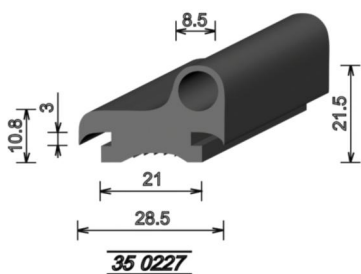
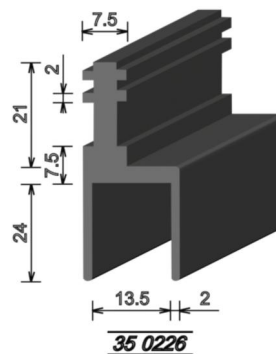
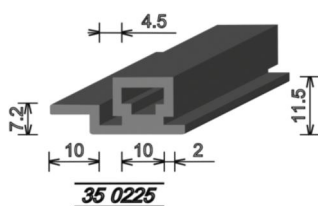
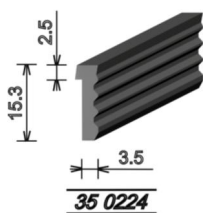
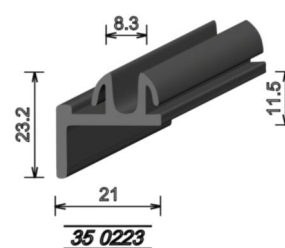
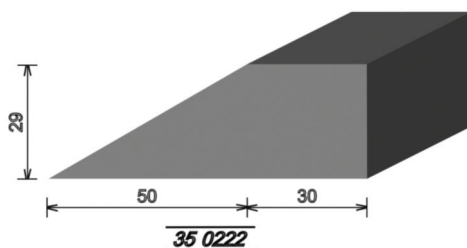
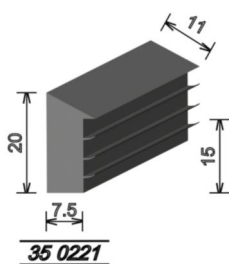
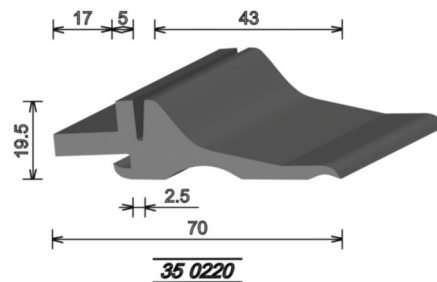
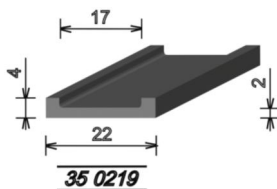
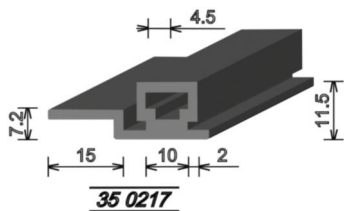

PROFILY Z EPDM-KOMPAKTNEJ GUMY

Ukážky jednotlivých profilov

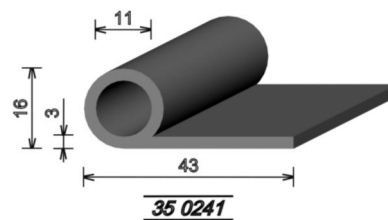
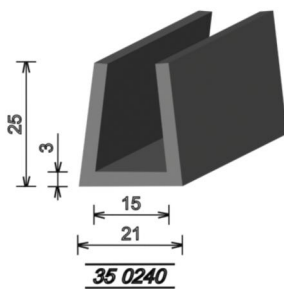
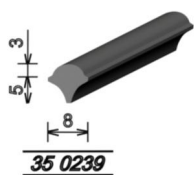
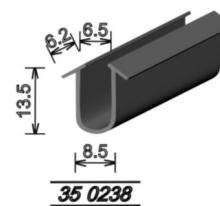
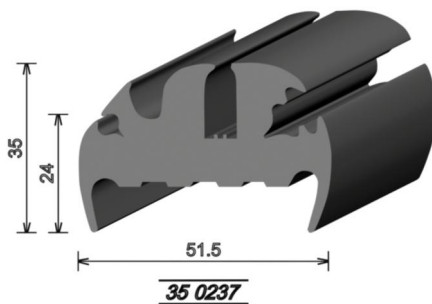
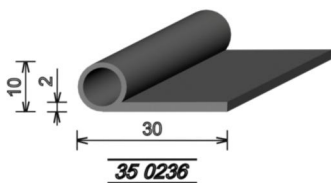
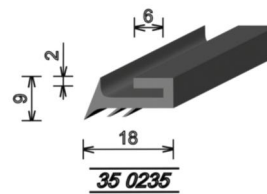
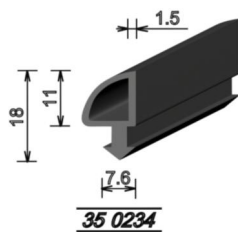
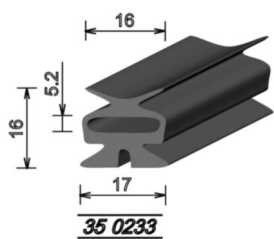
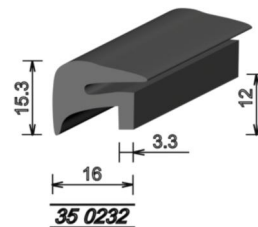
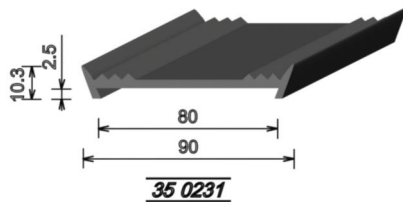
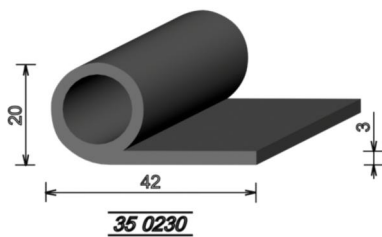

PROFILY Z EPDM-KOMPAKTNEJ GUMY

Ukážky jednotlivých profilov

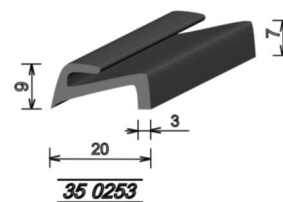
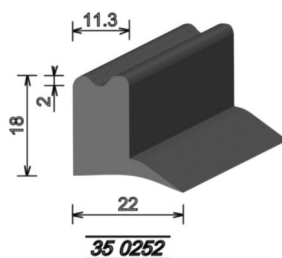
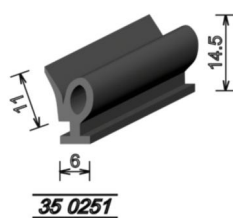
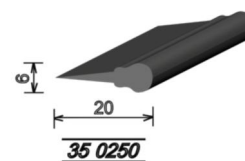
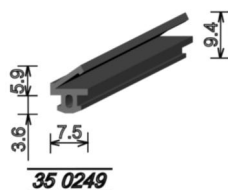
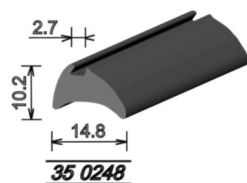
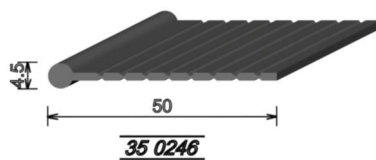
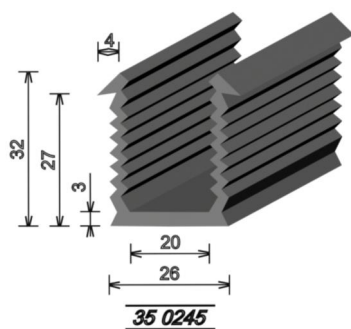
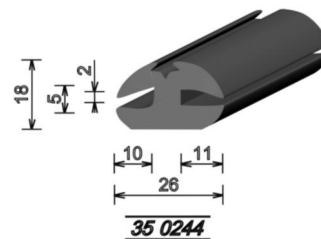
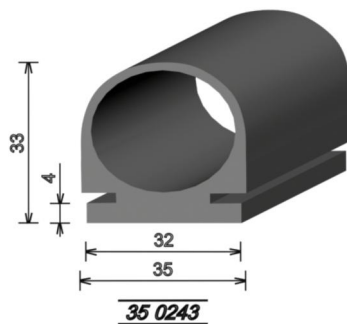
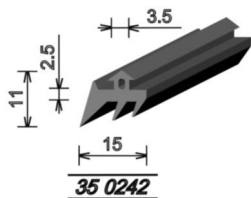

PROFILY Z EPDM-KOMPAKTNEJ GUMY

Ukážky jednotlivých profilov

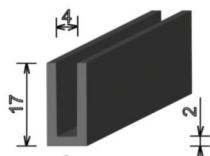

35 0254

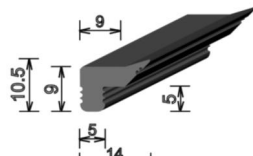

35 0255

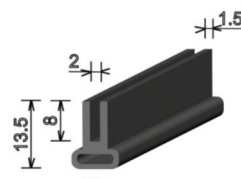

35 0256

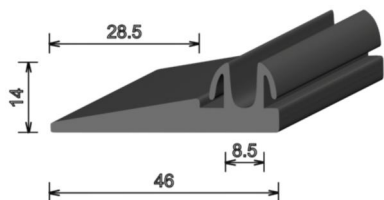

35 0257

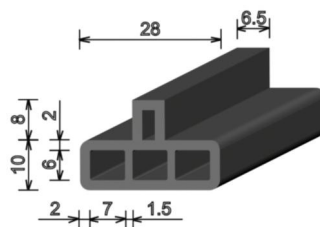

35 0258

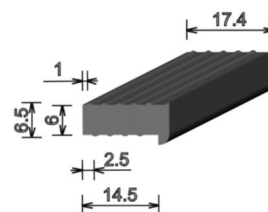

35 0259

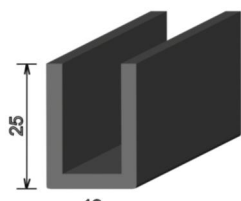

35 0260

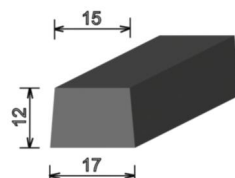

35 0261

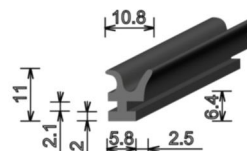

35 0262

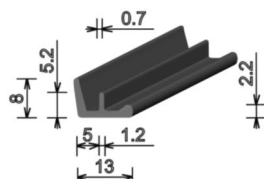

35 0263

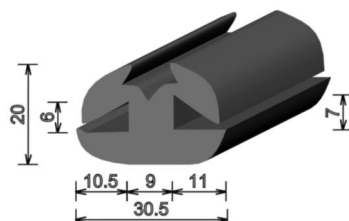

35 0264

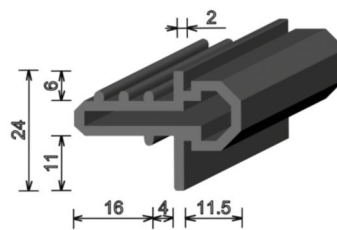

35 0265

PROFILY Z EPDM-KOMPAKTNEJ GUMY

Ukážky jednotlivých profilov

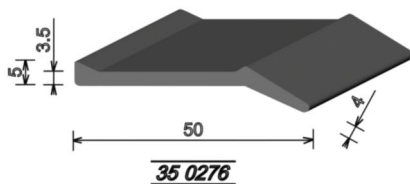
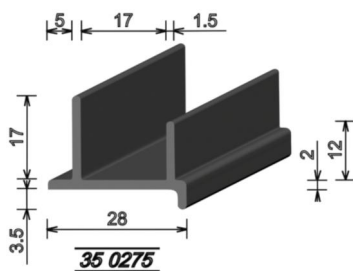
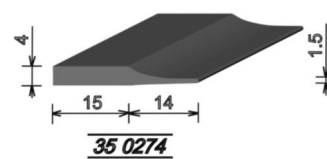
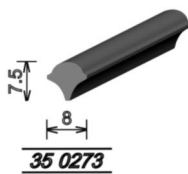
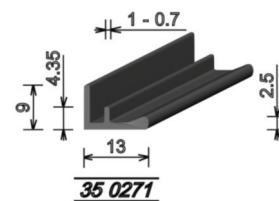
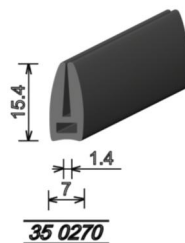
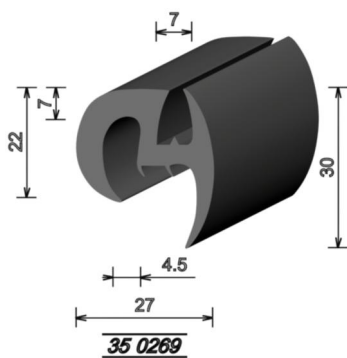
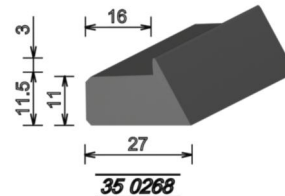
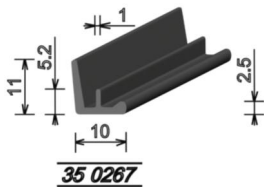
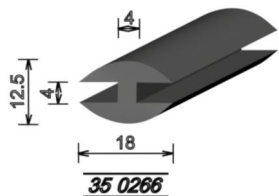

PROFILY Z EPDM-KOMPAKTNEJ GUMY

Ukážky jednotlivých profilov

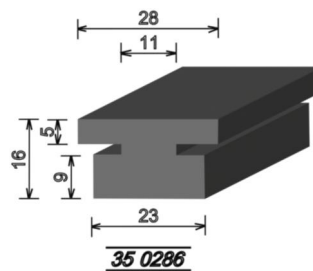
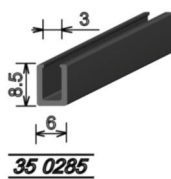
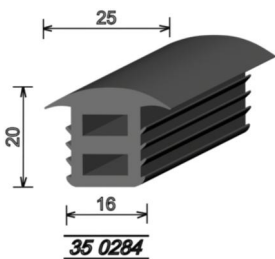
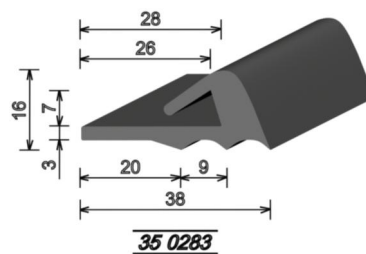
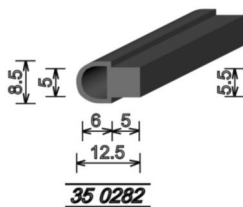
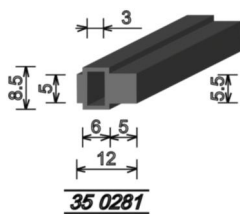
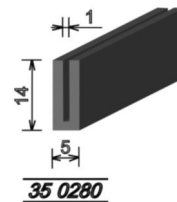
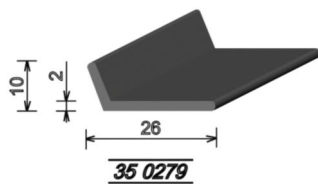
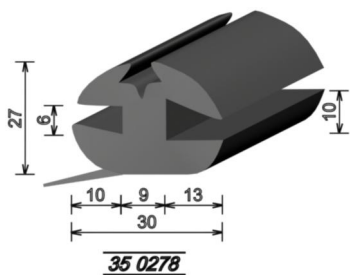

PROFILY Z EPDM-KOMPAKTNEJ GUMY

Ukážky jednotlivých profilov

